

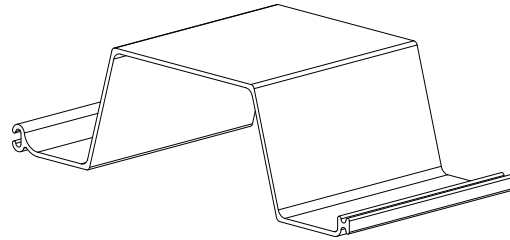

SG-325



Drawn: JAB Date: 06/18/09

Allowable Moment (M)	2,960 ft-lb/ft	13.17 kN-m/m
Section Modulus (Z)	11.1 in ³ /ft	597 cm ³ /m
Moment of Inertia (I)	39 in ⁴ /ft	5,326 cm ⁴ /m
Impact Strength	13,750 in-lbs/in ²	2,406 N-mm/mm ²
Thickness (t)	0.250 in	6.4 mm
Section Depth	7.0 in	178 mm
Section Width	24 in	610 mm
Material	Weatherable Rigid Vinyl	
Standard Colors	Grey, Clay	
Profile/Patented Features	Box Profile, I-Beam Lock	
Standard Packaging	20 sheets/bundle	

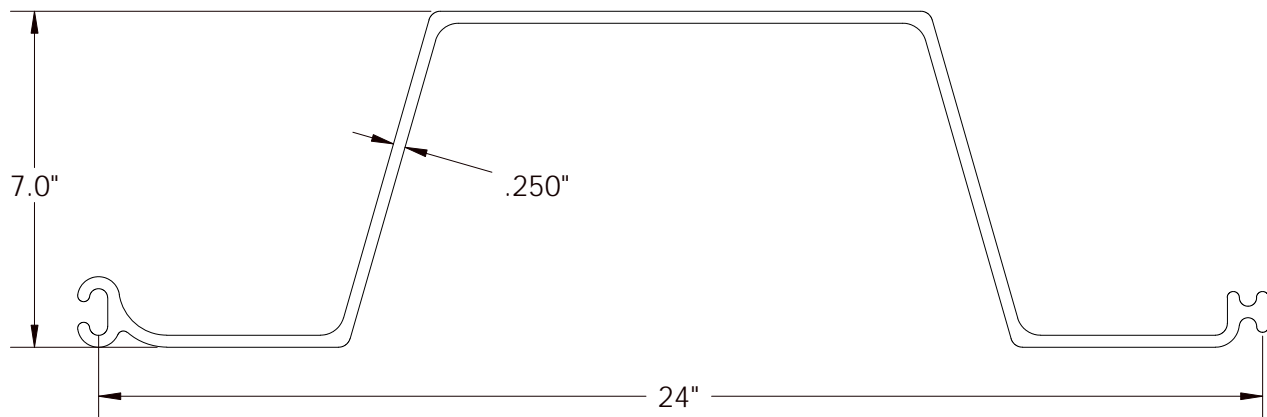

Physical properties are defined by ASTM testing standards, The Aluminum Association Design Manual, and/or standard engineering practice. The values shown are nominal and may vary. The information found in this document is believed to be true and accurate. No warranties of any kind are made as to the suitability of any CMI product for particular applications or the results obtained there from. ShoreGuard, C-Loc, TimberGuard, GeoGuard, Dura Dock, Shore-All, and Gator Gates are registered trademarks of Crane Materials International. ArmorWare, Ultra Composite, GatorDocks, GatorBridge and CMI Waterfront Solutions are trademarks of Crane Materials International. United States and International Patent numbers 5,145,287; 6,000,883; 6,033,155; 6,053,666; D420,154; 6,575,667; 7,059,807; 7,056,066; 7,025,539; 7,393,482; Other patents pending. © 2009 Crane Materials International. All Rights Reserved.